

Bellows-Sealed Valves



BN Series

- Packless valves with all-metal seal to atmosphere
- Working pressures up to 500 psig (34.4 bar)
- Temperatures up to 200°F (93°C)
- 1/4 to 1/2 in. and 6 to 12 mm end connections

Contents

Features	2	Flow Data at 70°F (20°C)	6
Performance Specifications	2	Pneumatic Actuators	6
Materials of Construction	3	Options and Accessories	7
Technical Data	3	Multiport and Elbow Valves and Monoblock Manifolds	7
Ordering Information and Dimensions	4		
Process Specifications	5		

Features

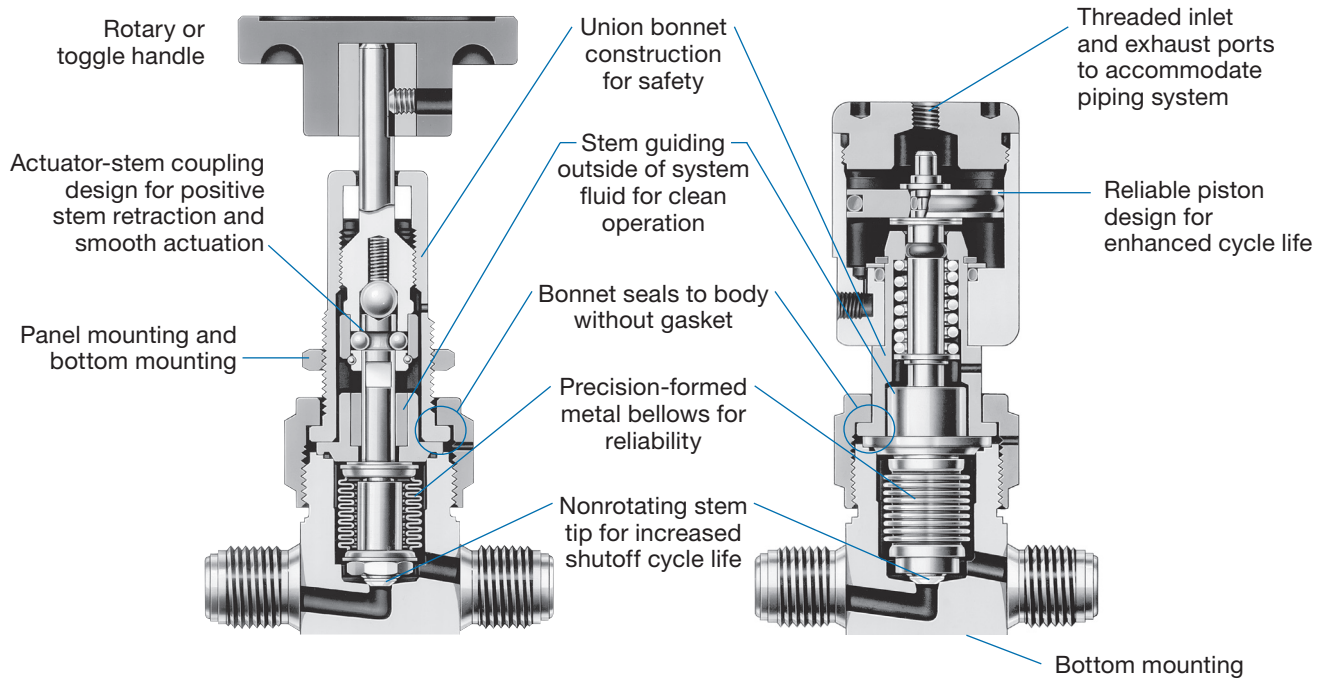

Valve

- 316L stainless steel construction—316L VAR for bodies with butt weld end connections
- Flow coefficients (C_v): 0.30 and 0.70
- Swagelok tube fitting, weld, and VCR® and VCO® fitting end connections
- Butt-weld ended valves are weldable with the Swagelok welding system
- Full pressure rating in either flow direction for system versatility
- Easily purged to maintain clean operation

Pneumatic Actuator

- Normally closed (C) model requires air to open and spring to close.
- Normally open (O) model requires air to close and spring to open.
- Pneumatic actuator rotates 360° for ease of installation.
- Green cap identifies normally open model.

Performance Specifications

Refer to *BN Series Bellows Valve Technical Report, MS-06-12*, for additional information on surface finish specifications, particle counting, moisture analysis, hydrocarbon analysis, ionic cleanliness, and lab cycle testing data.

Materials of Construction

Valve

Component	Material Grade/ ASTM Specification
1a Toggle handle Handle pin	Black nylon 302 SS
1b Rotary handle Set screw	Green phenolic Alloy steel/ANSI 18.3
1c Pneumatic actuator	See table below
2 Panel mount nut	316 SS/B783
3 Bonnet nut	Silver-plated 316 SS/A479
4 Stem guide	6/6 nylon/D4066
5 Bonnet ^①	316 SS/A479
6 Stem wiper	PTFE/AMS 3656
7 Spring	S17700 SS/AMS 5678
8 Washer	304 SS/A276
9 Actuator ^② Bearings (3) ^②	S17400 SS/A564 Chrome steel
10 Retaining ring	302 SS or 15-7 PH [®] SS
11 Spring	302 SS/A313
12 Ball bearing ^②	440C SS
13 Bearing retainer	316 SS/A479
14 <i>Stem</i> <i>Bushing</i> <i>Weld ring</i> <i>Bellows</i>	<i>316L SS/A479</i> <i>Phosphor bronze</i> <i>316L SS/A479</i> <i>300 series SS/A269 or A240</i>
15 Gasket	PCTFE
16 Adapter	316L SS/A479
17 Stem insert	PCTFE
18 Body	316L SS/A479 ^③

Wetted components listed in *italics*.

① Molybdenum disulfide-based lubricant.

② Petroleum-based lubricant.

③ Bodies with butt weld ends are 316L VAR SS/SEMI F20 High-Purity, 20 % minimum elongation allowed.

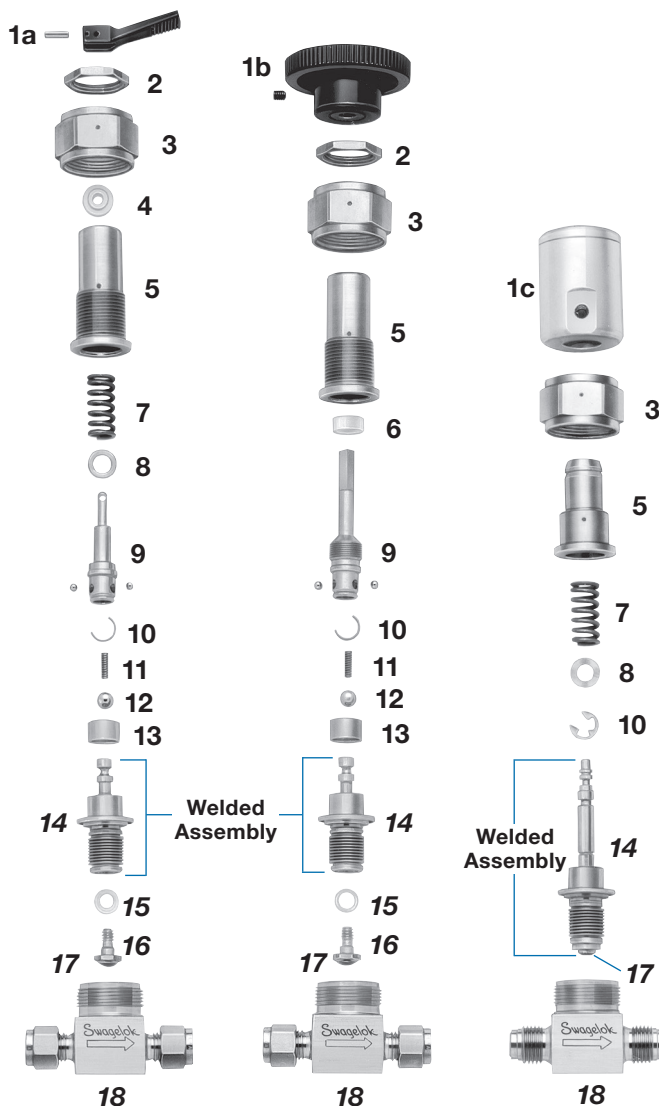

Pneumatic Actuator

Component	Material Grade/ ASTM Specification
Cap, piston, cylinder	Aluminum
O-rings	Fluorocarbon FKM
Spring washer	301 SS
Flat washers	304 SS/A240
Retaining ring	15-7 PH SS

Technical Data

Valve Series	Orifice in. (mm)	Flow Coefficient (C_v) ^①	Internal Volume ^① in. ³ (cm ³)	Valve Ratings		Actuator Ratings		
				Pressure vacuum to...psig (bar)	Temperature °F (°C)	Pressure psig (bar)	Temperature °F (°C)	Air Displacement (Actual Volume) in. ³ (cm ³)
BN4	0.157 (4.0)	0.30	0.18 (2.9)	Rotary handle—500 (34.4) Toggle handle—100 (6.8) Normally closed—125 (8.6) Normally open—400 (27.5)	−40 to 200 (−40 to 93)	60 to 120 (4.1 to 8.2)	−10 to 300 (−23 to 148)	0.045 (0.73)
BN8	0.313 (8.0)	0.70	0.27 (4.4)					

① Determined using valves with male VCR fitting end connections.

Ordering Information and Dimensions

Select an ordering number from the table at right.

Dimensions, in inches (millimeters), are for reference only and are subject to change. Dimensions shown with Swagelok tube fitting nuts finger-tight.

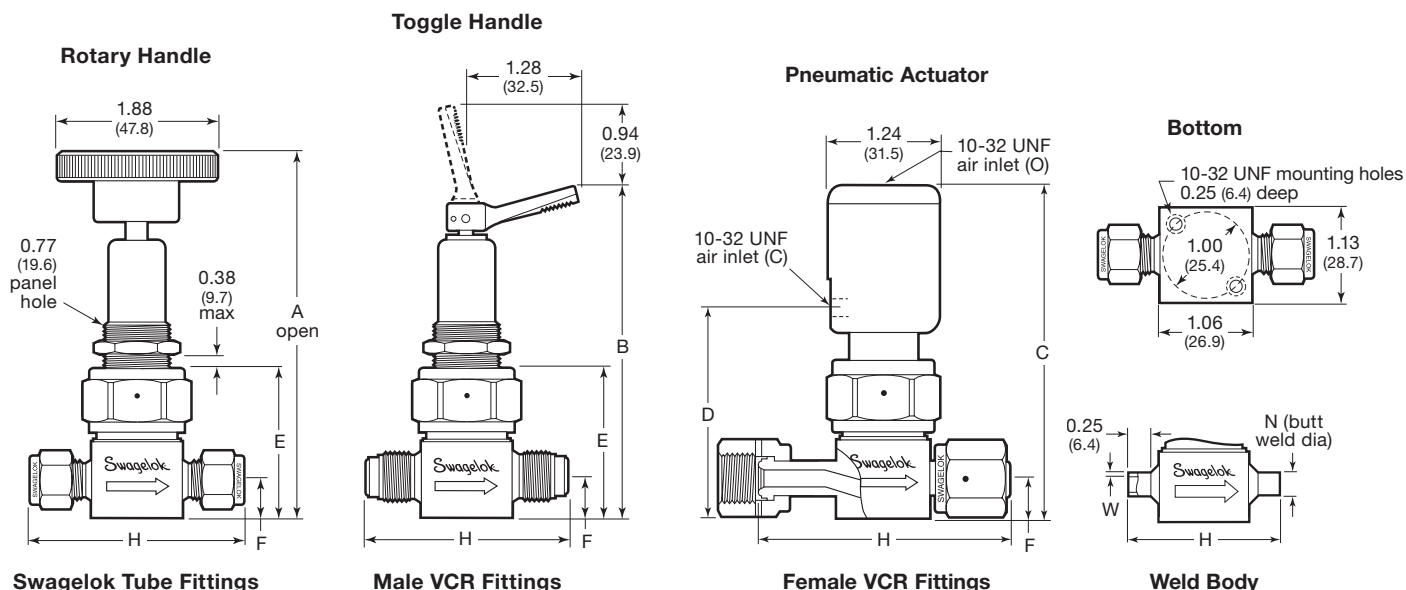

End Connections		Ordering Number	Dimensions, in. (mm)																
			Rotary	Toggle	Pneumatic		All Models			Weld Bodies									
Inlet/Outlet	Size		A	B	C	D	E	F	H	N	W								
BN4 Series																			
Swagelok tube fittings	1/4 in.	SS-BNS4	4.33 (110)	3.85 (97.8)	3.67 (93.2)	2.31 (58.7)	1.72 (43.7)	0.45 (11.4)	2.46 (62.5)	—	—								
	3/8 in.	SS-BNS6							2.58 (65.5)										
	6 mm	SS-BNS6MM							2.46 (62.5)										
	8 mm	SS-BNS8MM							2.53 (64.3)										
Butt weld ends	1/4 in.	6LV-BNBW4							4.33 (110)			3.85 (97.8)	3.67 (93.2)	2.31 (58.7)	1.72 (43.7)	0.45 (11.4)	0.25 (6.4)	0.035 (0.89)	—
	3/8 in.	6LV-BNBW6															0.38 (9.6)		
	6 mm	6LV-BNBW6MM															(6)		
Tube weld ends	1/4 in.	SS-BNTW4							4.33 (110)			3.85 (97.8)	3.67 (93.2)	2.31 (58.7)	1.72 (43.7)	0.45 (11.4)	1.75 (44.4)	0.38 (9.6)	0.060 (1.5)
Integral male VCR fittings	1/4 in.	SS-BNVCR4															2.30 (58.4)	—	—
Integral male VCO fittings	1/4 in.	SS-BNVCO4															2.00 (50.8)		
Female VCR fittings	1/4 in.	SS-BNV51 ^①	2.76 (70.1)																
Female/male VCR fitting	1/4 in.	SS-BNV51-VCR4	2.54 (64.5)																

^① Use ordering number **SS-BNFR4-P** to obtain processing and surface finish in accordance with *Ultra-high-Purity Process Specification (SC-01)* catalog, [MS-06-61](#).

Ordering Information and Dimensions

End Connections		Ordering Number	Dimensions, in. (mm)								
			Rotary	Toggle	Pneumatic		All Models			Weld Bodies	
Inlet/Outlet	Size		A	B	C	D	E	F	H	N	W
BN8 Series											
Swagelok tube fittings	3/8 in.	SS-BN8S6	4.42 (112)	3.93 (99.8)	3.76 (95.5)	2.40 (61.0)	1.81 (46.0)	0.53 (13.5)	2.58 (65.5)	—	—
	1/2 in.	SS-BN8S8							2.80 (71.1)		
	10 mm	SS-BN8S10MM							2.60 (66.0)		
	12 mm	SS-BN8S12MM							2.80 (71.1)		
Butt weld ends	3/8 in.	6LV-BN8BW6	4.60 (117)	4.11 (104)	3.93 (99.8)	2.58 (65.5)	1.99 (50.5)	0.66 (16.8)	1.74 (44.2)	0.38 (9.6)	0.035 (0.89)
	1/2 in.	6LV-BN8BW8							0.50 (12.7)	0.049 (1.2)	
Tube extension ends	1/2 in.	SS-BN8T8A	4.54 (115)	4.06 (103)	3.88 (98.6)	2.53 (64.3)	1.93 (49.0)	0.66 (16.8)	3.40 (86.4)	—	—
Integral male VCR fittings	1/2 in.	SS-BN8VCR8							2.58 (65.5)	—	—
Female VCR fittings	1/2 in.	SS-BN8FR8	4.54 (115)	4.06 (103)	3.88 (98.6)	2.53 (64.3)	1.93 (49.0)	0.66 (16.8)	3.15 (80.0)	—	—

Process Specifications

See Swagelok *Ultrapurity Process Specification (SC-01)* catalog, [MS-06-61](#), Swagelok *Photovoltaic Process Specification (SC-06)* catalog, [MS-06-64](#), and Swagelok *Special Cleaning and Packaging (SC-11)* catalog, [MS-06-63](#), for details on processes, process controls, and process verification.

Cleaning	Assembly and Packaging	Process Designator	Process Specification	Wetted Surface Roughness (R_a)	Testing
Special cleaning with non-ozone-depleting chemicals	Performed in specially cleaned areas; valves are individually bagged.	None	<i>Special Cleaning and Packaging (SC-11)</i>	20 $\mu\text{in.}$ (0.51 μm) average, machine finished	Inboard helium leak tested to a rate of 4×10^{-9} std cm^3/s at the seat, envelope, and all seals
High-purity cleaning with a continuously monitored, deionized water, ultrasonic cleaning system	Performed in specially cleaned areas; valves are individually bagged.	-SC06	<i>Photovoltaic Process Specification (SC-06)</i>	20 $\mu\text{in.}$ (0.51 μm) average, machine finished	
High-purity cleaning with a continuously monitored, deionized water, ultrasonic cleaning system	Performed in specially cleaned areas; valves are individually bagged.	-P6	<i>Photovoltaic Process Specification (SC-06)</i>	8 $\mu\text{in.}$ (0.20 μm) average, machine finished and electropolished	
Ultrapurity cleaning with a continuously monitored, deionized water, ultrasonic cleaning system	Performed in ISO Class 4 work areas; valves are double bagged and vacuum sealed in cleanroom bags.	-P	<i>Ultrapurity Process Specification (SC-01)</i>	8 $\mu\text{in.}$ (0.20 μm) average, machine finished and electropolished	

Standard (SC-11)

Swagelok BN series valves are processed in accordance with Swagelok *Special Cleaning and Packaging (SC-11)* catalog, [MS-06-63](#), to ensure compliance with product cleanliness requirements as stated in ASTM G93 Level C.

Photovoltaic (SC-06)

Swagelok BN series valves with VCR or weld end connections are available cleaned and packaged in accordance with Swagelok *Photovoltaic Process Specification (SC-06)* catalog, [MS-06-64](#), to meet the process requirements of solar cell production. To order, add **-SC06** to the ordering number.

Example: SS-BNBW4-**SC06**

SC-06-cleaned BN series valves with VCR or weld end connections are available with controlled wetted surface finishes and electropolishing. To order, add **-P6** to the ordering number.

Example: SS-BNVCR4-**P6**

Ultrapurity (SC-01)

Swagelok BN series valves with VCR or weld end connections are available with wetted surface finishing, cleaning, and packaging in accordance with Swagelok *Ultrapurity Process Specification (SC-01)* catalog, [MS-06-61](#). To order, add **-P** to the ordering number.

Example: SS-BNBW4-**P**

Exception: Use ordering number **SS-BNFR4-P** to obtain SC-01 processing and surface finish for SS-BNV51.

Flow Data at 70°F (20°C)

- BN4 Series** — — Toggle Handle
— Rotary Handle and Pneumatic Actuator
- BN8 Series** — — Toggle Handle
— Rotary Handle and Pneumatic Actuator

Air

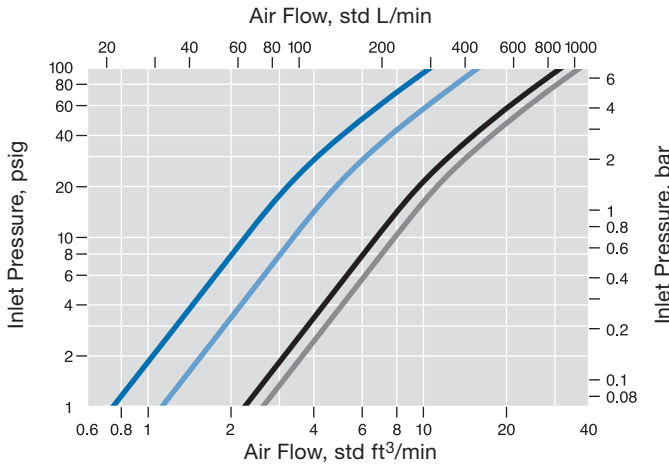

Water

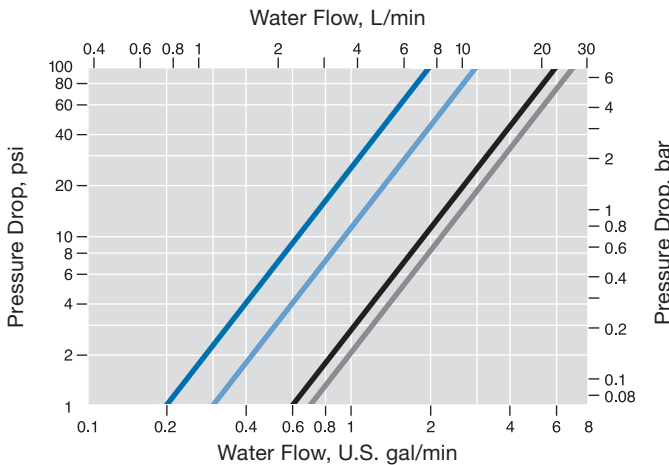

Rotary Model Flow Coefficient at Turns Open

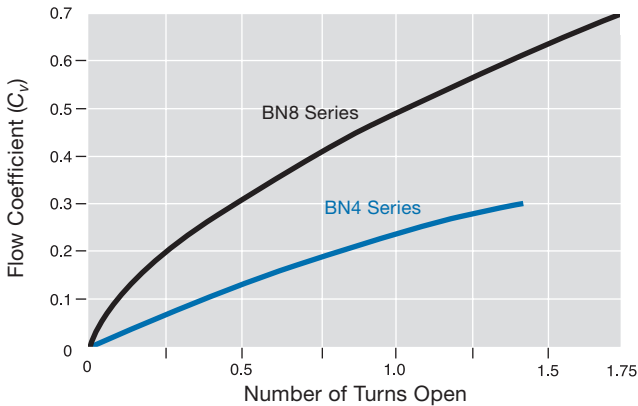

Pneumatic Actuators

To order a pneumatically actuated valve, add **-C** for normally closed or **-O** for normally open to the valve ordering number.

Examples: SS-BNS4-C
 SS-BNS4-O

Pneumatic Actuator Performance

Actuator Pressure at System Pressure

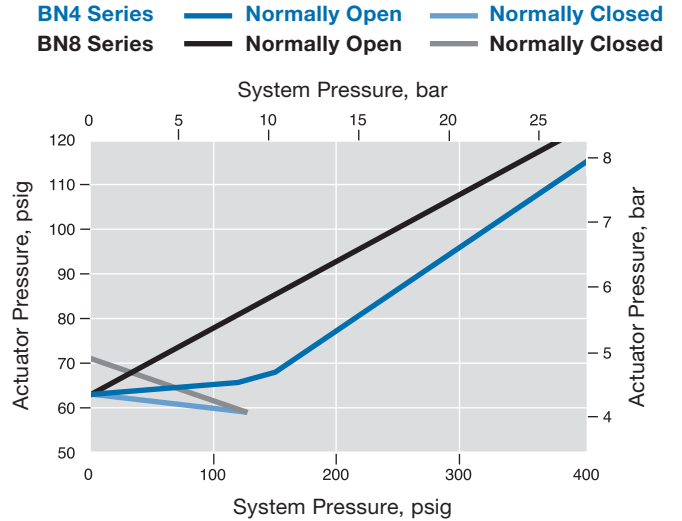

Optional Pneumatic Actuator Inlet Port

Standard inlet port is 10-32 UNF. A 1/8-27 NPT inlet port is available. The normally closed model has a cylinder extension to accommodate the larger port. To order, insert **2** in the valve ordering number.

Examples: SS-BNS4-2C
 SS-BNS4-2O

Hose Adapter Kits

Allows for use of soft plastic or rubber tubing at the inlet of the pneumatic actuator.

- Adapts pneumatic actuator port from the 10-32 UNF thread to 1/8 in. hose barb.
- Includes a nickel-plated brass hose barb fitting and Buna N gasket.

Kit ordering number: **B-BN4-K62**

Pneumatic Actuators

Bonnet Sniffer Tubes

Bonnet sniffer tubes allow monitoring of bellows integrity.

- 3/16 in. (4.7 mm) outside diameter, 1.38 in. (34.9 mm) long.
- 316 stainless steel material with fluorocarbon FKM O-ring.
- Threads to test port of bonnet.
- Pneumatically actuated valves only.

To order, add **-T** to the valve ordering-number.

Example: 6LV-BNBW4-C-T



Sniffer Tube

Indicator Switches

- Transmits a signal to an electrical device indicating either the open or closed position of a pneumatically actuated valve.
- Features a single-pole, single-throw switch rated at:
 - 1/2 A for 115 V (ac) for normally open switch;
 - 1/4 A for 115 V (ac) for a normally closed switch;
 - -40 to 185°F (-40 to 85°C) temperature.
- Includes a 24 in. (61 cm) wire lead with an inline clip.
- Is available assembled on any normally closed BN series or for field assembly.



Factory-Assembled Indicator Switches

To order a valve with an indicator switch, add **M** for a normally open switch or **M-2** for a normally closed switch to the valve ordering number.

Examples: SS-BNS4-CM
SS-BNS4-CM-2

Indicator Switch Kits

To order a kit for an existing valve, use ordering number **MS-ISK-BN-CM** for a normally open switch or **MS-ISK-BN-CM-2** for a normally closed switch.

Options and Accessories

Polyimide Stem Tips

A PCTFE stem tip is standard. Polyimide stem tips are available in BN4 series valves, for temperatures up to 400°F (204°C) or where PCTFE is not compatible with the system fluid.

To order, insert **V** in the valve ordering number.

Example: SS-BNVS4-C

Replacement polyimide stem tips are available for manually operated valves. Replacement stem tips for pneumatically actuated valves are part of the bellows/stem/stem tip subassembly. Refer to *Bellows Valve Maintenance Kits* catalog, [MS-02-66](#), for additional information.



Polyimide Stem Tip

(Manually operated valve stem tip shown)

Toggle Handles

Ordering numbers specify rotary handle valves. To order a toggle-operated valve, insert **T** in the valve ordering number.

Example: SS-BNTS4

Black handles are standard for toggle-operated BN series valves. To order a colored toggle handle, add a handle color designator to the valve ordering number.

Example: SS-BNTS4-**BL**

Handle Color	Designator
Blue	-BL
Green	-GR
Orange	-OG
Red	-RD
White	-WH
Yellow	-YW

Maintenance Kits

Stem tip/adaptor kits are available for manual BN series valves; bellows/stem/stem tip/adaptor kits are available for manual and pneumatic BN series valves. Refer to *Bellows-Sealed Valve Maintenance Kits* catalog, [MS-02-66](#).

Oxygen Service Hazards

For more information about hazards and risks of oxygen-enriched systems, refer to *Oxygen System Safety* technical report, [MS-06-13](#).

Multiport and Elbow Valves and Monoblock Manifolds

BN series valves are available in multiport and elbow configurations and monoblock manifolds; refer to *Bellows- and Diaphragm-Sealed Multiport and Elbow Valves and Monoblock Manifolds* catalog, [MS-02-442](#).

⚠ To increase service life, ensure proper valve performance, and prevent leakage, apply only as much torque as is required to achieve positive shutoff.

Safe Product Selection

When selecting a product, the total system design must be considered to ensure safe, trouble-free performance. Function, material compatibility, adequate ratings, proper installation, operation, and maintenance are the responsibilities of the system designer and user.

⚠ WARNING

Do not mix/interchange Swagelok products or components not governed by industrial design standards, including Swagelok tube fitting end connections, with those of other manufacturers.

Warranty Information

Swagelok products are backed by The Swagelok Limited Lifetime Warranty. For a copy, visit swagelok.com or contact your authorized Swagelok representative.

Swagelok, VCR, VCO—TM Swagelok Company
15-7 PH—TM AK Steel Corp.
© 2007–2025 Swagelok Company
MS-01-94, RevU, February 2025